



## MTL HART® SOLUTIONS

In Control Of HART  
MTL4840 Series  
Cornerstone  
AMS



# IN CONTROL OF HART® CONNECTIONS

If you've been future proofing your process infrastructure by specifying 'smart' field devices for instrument replacements and plant extensions, then you probably already have HART® instruments installed in the plant. But are you exploiting this considerable investment?

HART® provides simultaneous analogue and digital operation so that the 4/20mA analogue signal can be connected to conventional I/O cards for control while the digital signal can be used for:

- ◆ up to four process variables from each HART® device
- ◆ device status
- ◆ instrument diagnostics
- ◆ configuration changes

MTL's HART® connections provide the means to make full use of these features, and are an important part of the company's commitment to open systems. By connecting field instruments, control systems and instrument management software, MTL's HART® connections allow better use of maintenance resources, reduced commissioning and process down-time, and consequent lower costs for commissioning and loop maintenance.





The MTL4840 Series HART® connection is the solution for process control systems using traditional I/O and is described in the following pages. In addition, MTL's 8000 Process I/O™ system has a dedicated HART® connection to instrument management software. Process I/O™ communicates directly from the controller along an open bus to an I/O node located close to the field instruments, often in harsh or hazardous environments. HART® data can be passed transparently between the smart field instruments and the host control system, via the I/O modules.

For further information on this type of MTL HART® connection, see the Process I/O™ section.

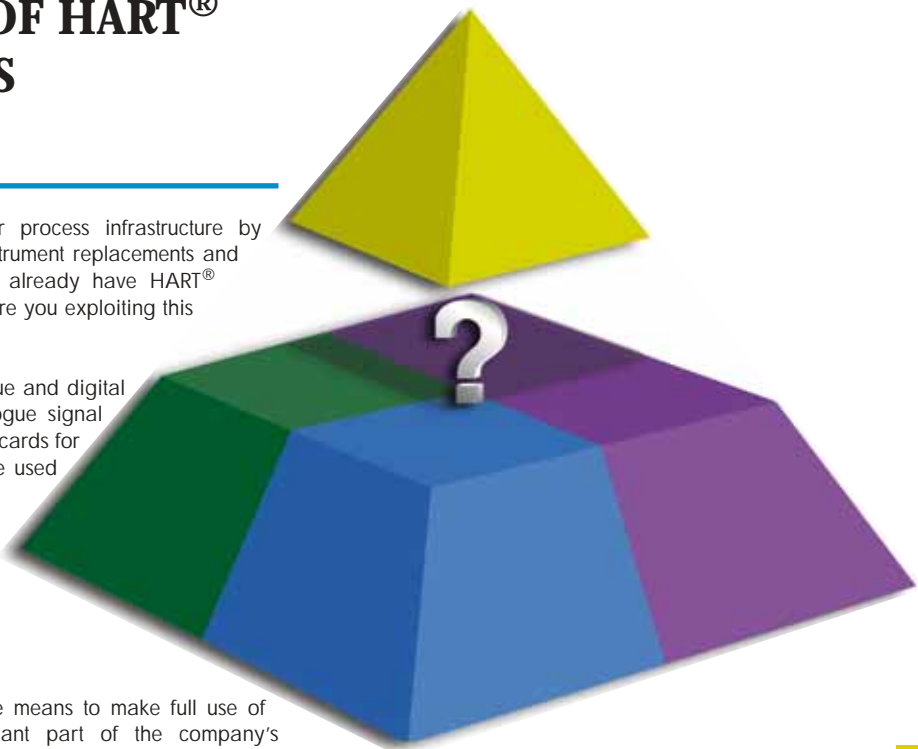
## INSTRUMENT MANAGEMENT SOFTWARE

MTL's HART® connections provide on-line access from a PC to HART® field devices. This allows the use of a growing variety of powerful instrument management software which, in turn, allows the user to monitor, configure, calibrate and maintain HART® devices, including valve positioners and transmitters. Depending on the software used, HART® devices may be selected for regular status monitoring, with an alert issued if the status changes, and other fieldbus instruments may be integrated into the same system database.



- Instrument Management Software 
- MTL HART® connection 
- General purpose field instruments 
- Intrinsically safe field instruments 
- Control system 

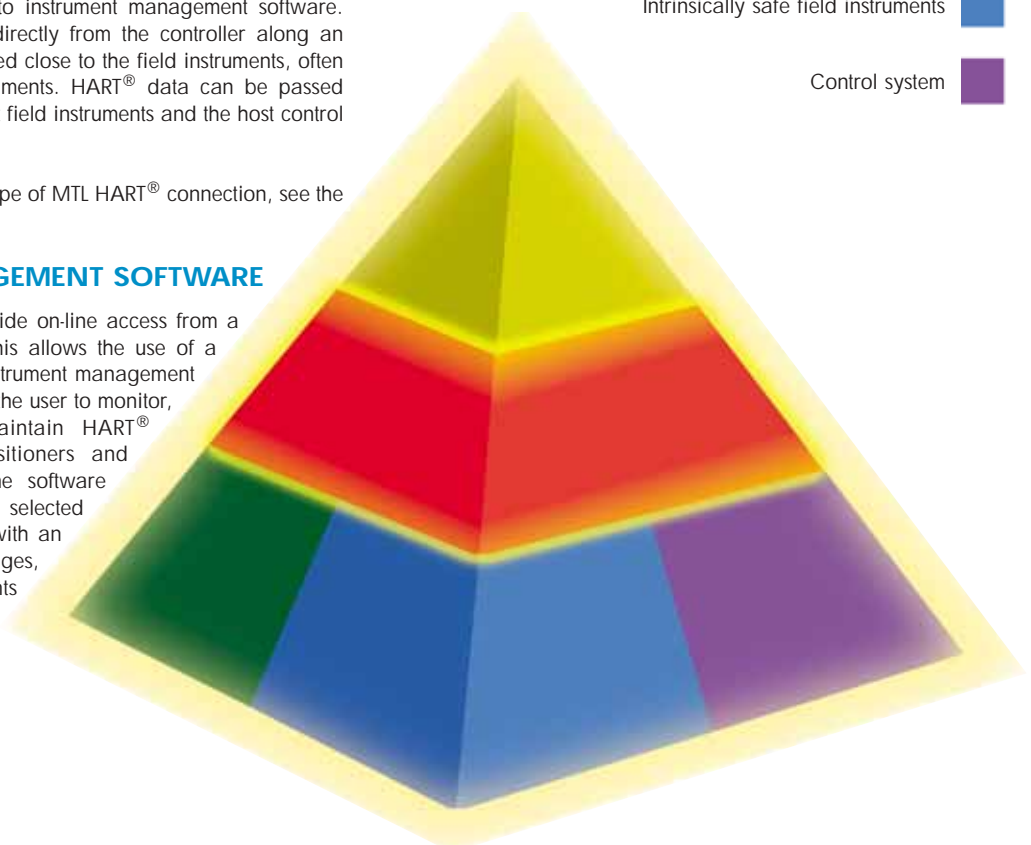

EUROPE (EMEA)  
AMERICAS  
ASIA PACIFIC  
E-mail: [enquiry@mtl-inst.com](mailto:enquiry@mtl-inst.com)

Tel: +44 (0)1582 723633  
Tel: +1 603 926 0090  
Tel: +65 487 7887

Fax: +44 (0)1582 422283  
Fax: +1 603 926 1899  
Fax: +65 487 7997

Web site: [www.mtl-inst.com](http://www.mtl-inst.com)

# WHAT IS HART®?

HART® stands for:

## HIGHWAY ADDRESSABLE REMOTE TRANSDUCER

HART® is an open protocol that was originally developed in the late 1980's by Fisher Rosemount to communicate with their range of Smart field devices. Over the years it has become a de facto standard for communicating with SMART devices in the Process industry. Over 100 manufacturers utilise the HART® protocol in over 560 different products, from simple temperature transmitters to gas detectors.

The HART® protocol is a powerful communication technology used to realise the full potential of digital field devices whilst preserving the traditional 4-20mA signal. The HART® protocol extends the system capabilities for two way digital communication with smart instruments.

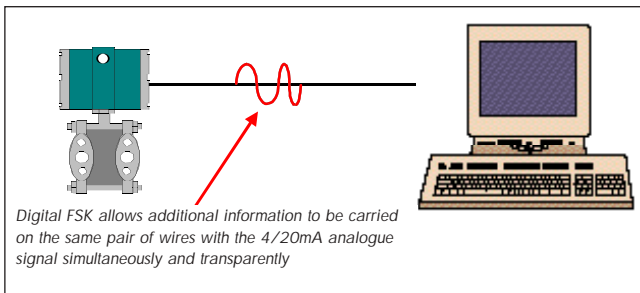

HART® offers the best solution for smart field device communications and has the widest base of support of any field device protocol worldwide. More instruments are available with the HART® protocol than any other digital communications technology. Almost any process application can be addressed by one of the products offered by HART® instrument suppliers. Unlike other digital communication methods the HART protocol gives a unique communication solution that it is backward compatible with currently installed instrumentation. This ensures that investments in existing cabling and current control strategies remain secure into the future.

The HART® digital signal is superimposed onto the standard 4-20mA signal. It uses Bell 202 standard Frequency Shift Keying (FSK) signal to communicate at 1200 baud. The digital signal is made up of two frequencies, 1200Hz and 2200Hz, representing bits 1 and 0 respectively. Sine waves of these two frequencies are superimposed onto the analogue signal cables to give simultaneous analogue and digital communications. As the average value of the FSK signal is always zero there is no effect on the 4-20mA analogue signal. A minimum loop impedance of 230ohms is required for communication.

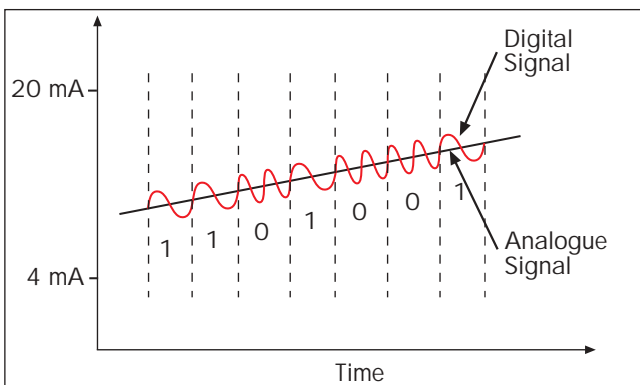

HART® is a master-slave protocol - this means that a field device only replies when it is spoken to. Up to two masters can connect to each HART® loop. The primary master is usually the DCS (Distributed Control System), the PLC (Programmable Logic Controller) or a PC. The secondary master can be a hand held configurator or another PC running an instrument maintenance software package. Slave devices include transmitters, actuators and controllers that respond to commands from the primary or secondary master.

The digital communication signal has a response time of approx. 2-3 updates per second without interrupting the analogue signal.

## HART® Commands

The HART® protocol provides uniform and consistent communication for all field devices via the HART® command set. This includes three types of Command:

### Universal

All devices using the HART® protocol must recognise and support these commands. They provide access to information useful in normal operations.

### Common Practice

These provide functions implemented by many but not all HART® communication devices.

### Device specific

These represent functions that are unique to each field device. They access set up and calibration information as well as information on the construction of the device.

The HART® Communication Protocol is an open standard owned by more than 100 member companies in the HART® Communication Foundation HCF. The HCF is an independent, non-profit organisation, which provides worldwide support for application of the technology and ensures that the technology is openly available for the benefit of the industry.



**MTL has been a full member of the HART® Communication Foundation since its formation in 1993.**



# HART® COMMUNICATION FOUNDATION

The HCF is an independent, not-for-profit organization funded by HCF membership & training/support fees. In addition the HCF:

- ◆ **owns and manages all elements of HART® technology**
- ◆ **enhances the technology as necessary to support industry needs for smart instrumentation.**
- ◆ **provides training workshops, newsletters, web site & other services to Educate Industry on the use of HART® communication.**
- ◆ **manages the library of Registered Device Descriptions**
- ◆ **represents HART® Technology at industry forums and technical symposiums.**

All major instrumentation suppliers support the HART® Protocol and available products cover the full range of process measurement. The following article by the HCF summarises the power of HART®.

**If you thought you knew HART® before... LOOK AGAIN!**

HART-capable instrumentation products are available around the globe for all process applications. Well known for their ease of remote configuration and device set-up, HART® smart devices also provide valuable information to improve process operations - every second of every day. Now, HART-capable control systems and cost-effective I/O solutions make it easier than ever to integrate HART® with plant systems and support real-time use of the valuable data in HART® devices from the plant floor to the highest levels of the enterprise.

## The ability to do more than you think

HART® is the leading communication technology for accessing the intelligent data in "smart" field instrumentation.

## HART® is:

- ◆ Field proven with millions of devices installed and working worldwide in process applications such as yours.
- ◆ A globally accepted standard supported by all major process control suppliers.
- ◆ Your most cost-effective process communication solution for improving plant operations and asset management.

## Things you probably know about HART

- ◆ Most smart instruments use HART® Communication.
- ◆ HART® smart field devices are used interchangeably with traditional analogue only units.
- ◆ Hand-held communicators are often used for device set-up, calibration, commissioning and periodic maintenance functions.
- ◆ PC-based instrument management tools can remotely communicate with HART devices to access device data and manage calibrations.
- ◆ HART® = cost savings for installation & management.

## Things you may NOT know about HART®

- ◆ All HART® smart devices provide valuable data for process operations 24/7 - every second of every day.
- ◆ Information on status (health) of the field devices and quality of the 4-20mA signals is in every communication.
- ◆ The Primary Variable is transmitted as a 4-20mA signal and also as a digital value.
- ◆ Many devices communicate Secondary Process Variables (measured or calculated) in addition to the Primary Variable.

## USING HART® DATA = MORE VALUE!

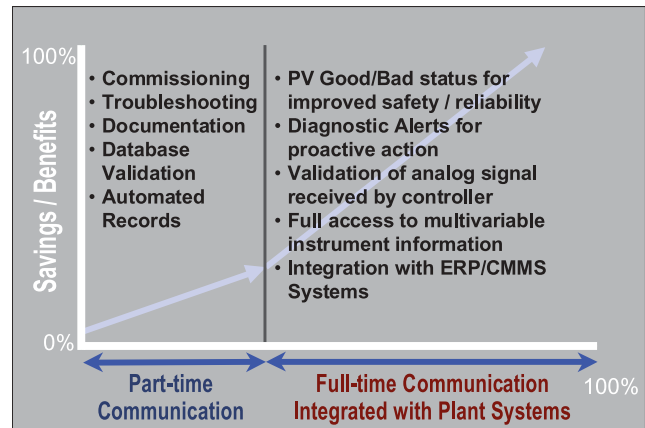

## Unleash the power of HART® communication

- ◆ In most installations, communication with HART® devices is occasional or infrequent at best.
- ◆ "Part-time" communication using hand-held communicators for commissioning and periodic maintenance is beneficial, but provides only a small portion of the value.
- ◆ "Full-time" communication is important to get the full value from your HART® assets.

## Continuously communicate to UNLEASH THE POWER

**VALUABLE DATA to improve process operations, every second of every day**

## What you should know about HART® Device Data

- ◆ **35-40 data items** are standard in every HART® device.
- ◆ Device Status, Diagnostic Alerts, Process Variables, Engineering Units, Loop Current, % Range, etc.
- ◆ Upper & Lower Range Values, Force Loop Current to specific value.
- ◆ Manufacturer Information, Device Tag.
- ◆ A device description (DD) is not necessary to access or interact with these standard data items.
- ◆ Standard commands provide easy data access.

**HART® data is valuable to more than just the instrument dept. Available data includes:**

- ◆ Process Variables.
- ◆ Device Status Alerts.
- ◆ Device Information.
- ◆ Basic Calibration Information.
- ◆ All data is easily available to your plant systems!



## **HART® provides access to ALL process variables in the device**

- ◆ Many HART® Devices provide more than one process measurement or calculated value.
- ◆ Many Pressure & Temperature devices.
- ◆ Most Flow, Level & Analytical devices.
- ◆ All Valve Positioners/Controllers.
- ◆ Process Variable data is transmitted digitally in IEEE Floating Point format with Engineering Units.
- ◆ The Primary Variable can be read as a digital value and is typically transmitted on the continuous 4-20mA signal.

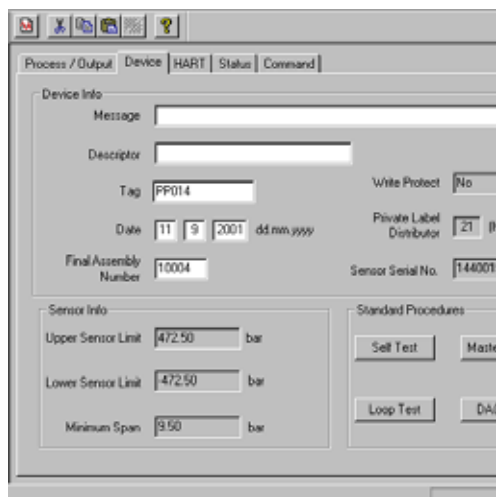

## **HART® Communication includes status & diagnostics**

- ◆ HART® devices continuously self-access and monitor their performance.
- ◆ Status information returned with every communication.
- ◆ Early warning of device problems.
- ◆ Analogue signal and data quality.

**COST-EFFECTIVE COMMUNICATION solution to better manage plant assets**

## **HART® delivers high value at minimal costs**

- ◆ Saves Time and Money.
- ◆ HART® capability provided at low or no additional cost in most devices.
- ◆ Easy installation and commissioning.
- ◆ Enhanced communication and diagnostics reduce maintenance and downtime.
- ◆ Protects Your Investments.
- ◆ Compatible with existing instrumentation, systems and people
- ◆ Allows incremental benefits to be achieved - one device at a time
- ◆ Get the benefits of enhanced field communications with minimal investment - no need to replace entire system.

## **Enables better management of plant assets**

- ◆ HART® Information Improves Plant Operation and Product Quality.
- ◆ Additional process variables and performance indicators.
- ◆ Continuous device status for early warning of problems.
- ◆ Digital capability ensures easy integration with plant networks
- ◆ Cost-effective Solutions for Plant Integration.
- ◆ Control system interfaces and HART® I/O for connection to one or a thousand devices.
- ◆ OPC Servers provide plant networks with easy access to HART® device data.
- ◆ Low cost interfaces and gateways for non-HART® capable systems.

**IMPROVED SYSTEM INTEGRITY - Increased reliability of control system information**

## **Continuous HART® communication improves system integrity**

- ◆ HART® smart devices continually self-access and monitor their performance.
- ◆ Information on device status, quality of 4-20mA signal and process variable good/bad status reported in every communication.
- ◆ Using this data in control and safety systems provides early warning of abnormalities before they become problems.
- ◆ Full-time communication with HART® devices increases the reliability of control and safety systems.

## **The Power of HART® Communication in Control Systems**

- ◆ Continuous monitoring of device status and diagnostic alerts
- ◆ Validate accuracy of data exchange between field devices and DCS/PLC.
- ◆ Access secondary variables in multi-variable devices for operator displays, trending, or control functions.
- ◆ Unlock the value of additional process measurements, calculated/totalizer values, valve positions, etc.

**POWERFUL TOOLS for easy plant integration**

## **Powerful tools for easy plant integration**

- ◆ Full cadre of software and hardware available to support all process applications
- ◆ Control systems, I/O, multiplexers, etc.
- ◆ Field devices 2 and 4 wire, analyzers, positioners, etc.
- ◆ Configuration, control, asset management and other software.
- ◆ Integration devices for delivering HART® data to analogue systems.
- ◆ Converters, signal conditioners and interfaces.
- ◆ Engineering, training, installation, configuration and commissioning are all facilitated by easy-to-use tools - no special training needed.

## **Getting HART® on plant networks**

- ◆ Digital HART® information ensures easy integration with plant systems.
- ◆ OPC Servers provide easy access to HART® device data on plant networks.
- ◆ Multiple applications can simultaneously access HART® data including popular HMI and Historical Trending packages.
- ◆ HART® capable I/O Systems and Interfaces support connection to one or thousands of devices.

**COMPLETE RANGE OF PRODUCTS**

## **Largest range of products and worldwide manufacturer support. Broad range of HART® capable products & technical support**

- ◆ Complete Range of HART® capable products available.
- ◆ Over 560 products from 111 different companies.
- ◆ All process measurement and control applications.
- ◆ Full compliment of software/hardware for plant integration.
- ◆ Technology supported by the 130+ Members of the HART® Communication Foundation representing the global leaders in process control.
- ◆ Membership spans the globe 46% North America, 44% Europe, 10% Asia & Australia.

## **Unleash the Power**

- ◆ HART® is your cost-effective, easy-to-use, high value and low risk process communication solution.
- ◆ If you have not looked at HART® recently, look again!
- ◆ HART® may be all the fieldbus you really need!

**Using the POWER of HART®, you may have more communication capability than you think!**





Communicate with, configure and monitor HART® smart devices in safe and hazardous areas

## MTL4840 SERIES



- ◆ SIL3 rating
- ◆ Connect up to 7936 loops to a single PC
- ◆ LED indication of loop being scanned
- ◆ Easily scalable modular system

- ◆ Compact, ideal for new projects and upgrades
- ◆ Channel to channel isolation option
- ◆ HART signal conditioning

The **MTL4840 HART® connection** system provides a simple interface between smart devices in the field and HART® instrument management software run on a PC.

The system is based on 16-channel modularity to provide a compact, easily configurable and expandable system. Using a standard RS485 serial link, up to 7936 individual HART® devices can be connected to a single workstation.

For the optimum solution, choose from a range of general purpose and IS termination boards. For maximum flexibility the BPHM64 HART® backplane locates an MTL4841 communications module and up to four MTL4842 interface modules. General purpose HART® connection units and IS backplanes are also available, each fitted with an interface cable for connection to the BPHM64 HART® backplane. MTL4841 and MTL4842 modules can also be located on HMU16 termination boards for general purpose applications or on BPMH16 / BPMH16U / BPSH16 / BPSH16-32 backplanes for IS isolator requirements.

The **DIN-rail mounting** HCU16 and HCU16AOHART® connect to 16 general purpose field instruments while maintaining channel to channel isolation. Resistor conditioning options are compatible with all I/O cards. It allows pass-through connections for transmitter power supply, input signal and common.

The **HCU16AO** unit includes HART® filters for I/O cards incompatible with HART® signals.

**BPMH16/BPMH16U/BPSH16/BPSH16-32** backplanes with MTL4840 HART® modules fitted, connect either 16 or 32 IS field instruments. Adapter cards are available for the BPMH16U for easy integration to I/O cards and users have a choice of a DIN-rail mounting option.

**Numerous features** may be included in the connection units and backplanes, as required. Channel to channel isolation; resistors where required for HART® signal conditioning; and HART® filters for analogue systems where the output signal interferes with HART® data or becomes unstable with the presence of the HART® signal.

**Customised backplanes and connection units** are available to provide direct connection from DCS I/O cables, replacing the standard termination board.

**MTL HART multiplexers** are certified by BASEEFA as a safety related sub-system to IEC61508. See the SR Series Interfaces section of this catalogue.



EUROPE (EMEA)  
AMERICAS  
ASIA PACIFIC  
E-mail: [enquiry@mtl-inst.com](mailto:enquiry@mtl-inst.com)

Tel: +44 (0)1582 723633  
Tel: +1 603 926 0090  
Tel: +65 487 7887

Fax: +44 (0)1582 422283  
Fax: +1 603 926 1899  
Fax: +65 487 7997

Web site: [www.mtl-inst.com](http://www.mtl-inst.com)

May 2004

# MTL4840 SERIES SYSTEM DIAGRAM

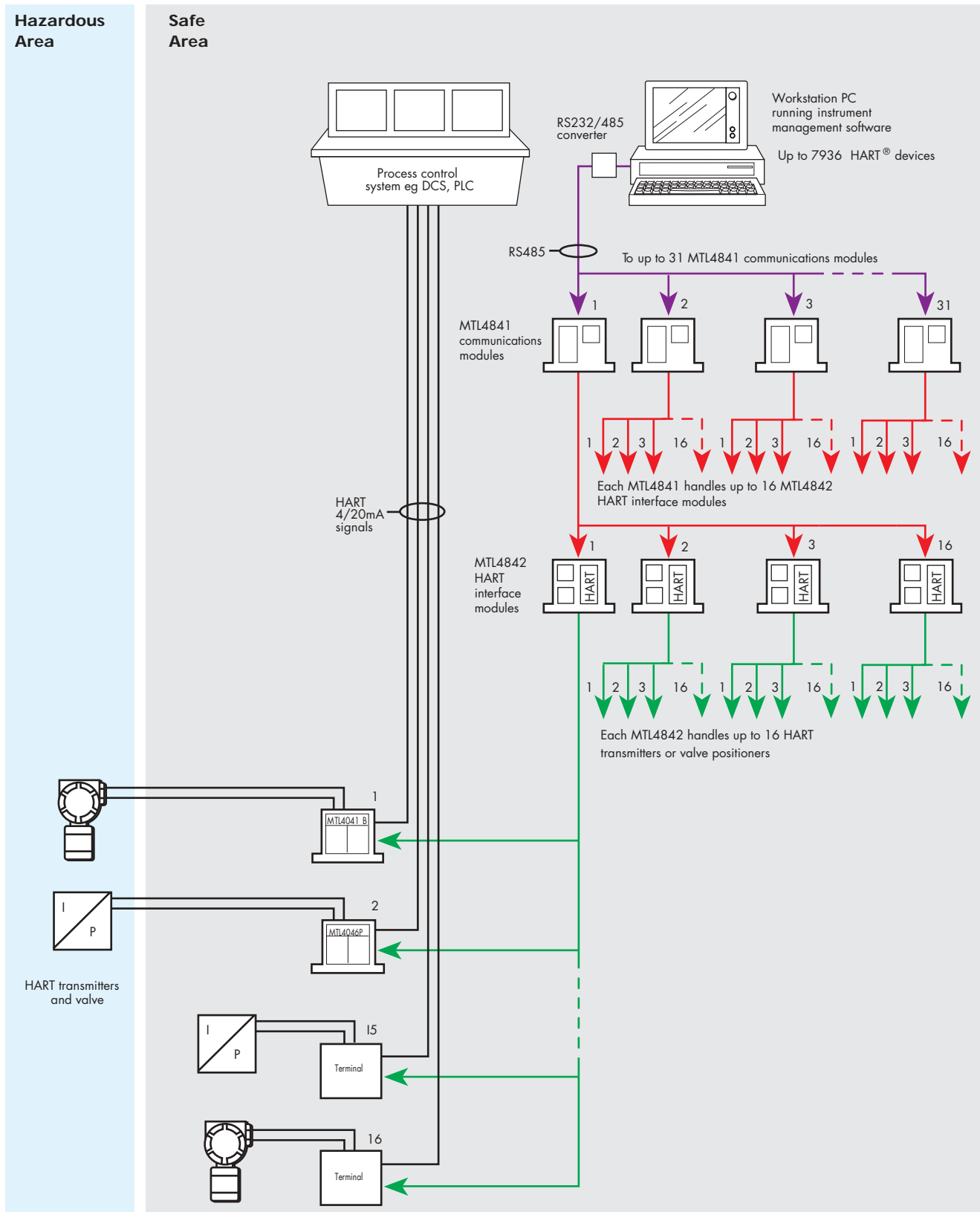

# MTL4840 SERIES MODULE SPECIFICATIONS

## MTL4841 COMMUNICATIONS MODULE

### Host system interface

RS485 2-wire multidrop  
Up to 31 MTL4841 modules can be connected to one host station  
Unit address: switch-selectable on top of module

### Isolation

RS485 output isolated from backplane power supply

### Serial communication parameters

RS485 Baud rate: 1.2, 9.6, 19.2, 38.4kbaud, switch-selectable on top of module  
RS485 highway length: up to 1km

### MTL system interface

Links with up to 16 MTL4842 HART® interface modules via interface bus on backplane/ribbon cable

### LED indicators

Green: one provided for power and status indication

### Power requirements

Powered from backplane

### Power consumption

<1.0W

### Instrument management software supported

See 'Instrument management software'

## MTL4842 HART® INTERFACE MODULE

### MTL systems interface

Links up to 16 loops via backplanes  
Receives multiplexer control signals via interface bus from MTL4841 and selects one channel for communication

### Unit address

Switch selectable on top of module

### Interface bus

Total length of interface bus between module 1 and module 16 must not exceed 4m

### LED indicators

Green: one provided for power  
Amber: one to indicate unit is selected by MTL4841  
Red: four to identify loop address

### Power requirements

Powered from backplane

### Power consumption

<0.1W

## MTL4000 SERIES MODULES

(See 'MTL4000 Series' for detailed specifications and circuit diagrams)

**MTL4041A:** Current repeater, 4/20mA, passive input for smart transmitters

**MTL4041B:** Repeater power supply, 4/20mA, for 2- or 3-wire transmitters

**MTL4041P:** High power repeater power supply, 4/20mA, for 2- or 3-wire transmitters

**MTL4044:** Repeater power supply, 4/20mA, two channel, for 2 wire transmitters

**MTL4046/C:** Isolating driver, for HART® valve positioners

**MTL4046P:** High power isolating driver for HART® valve positioners

## COMMON SPECIFICATION

(applies to all MTL4840 and 4000 Series modules)

### Location of units

Safe area (MTL4840 can be located in Div2)

### Long-term drift

No recalibration necessary

### Ambient temperature limits

-20 to +60°C continuous working  
-40 to +80°C storage

### Humidity

5 to 95% RH (non-condensing)

### Mounting

On MTL or custom backplanes which, in turn, can be surface or DIN-rail mounted.

Mounting pitch 16mm

### Weight

100g approximately

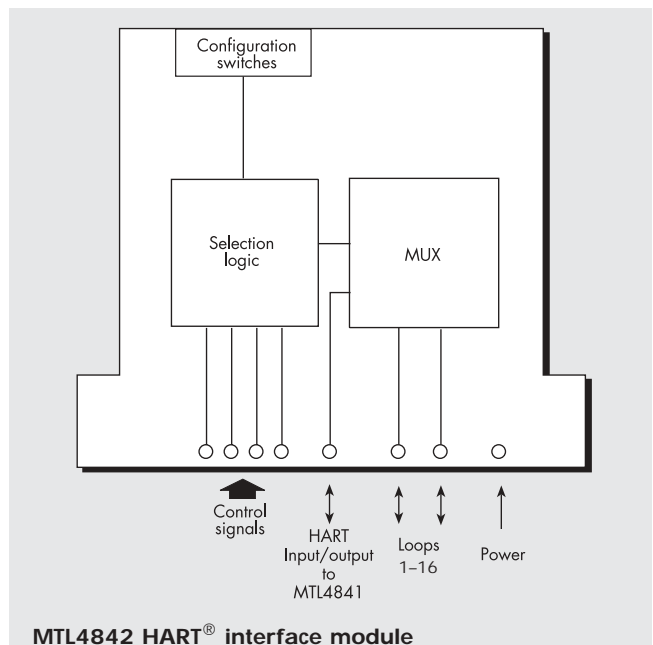
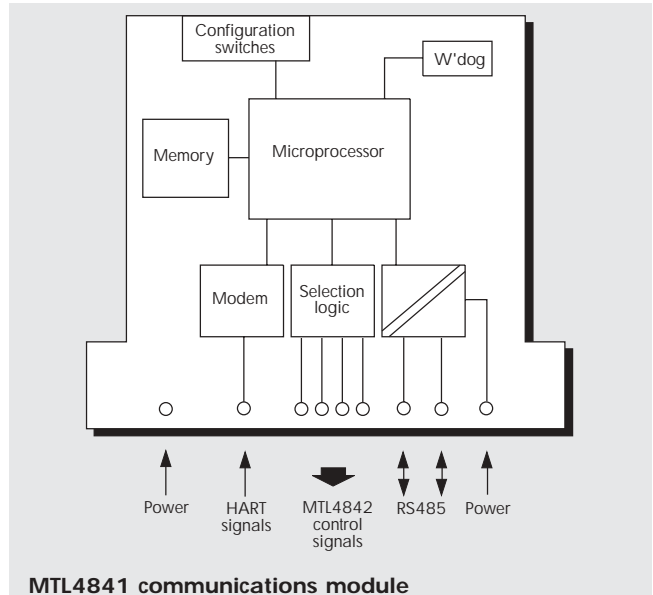

## DIMENSIONS (mm)

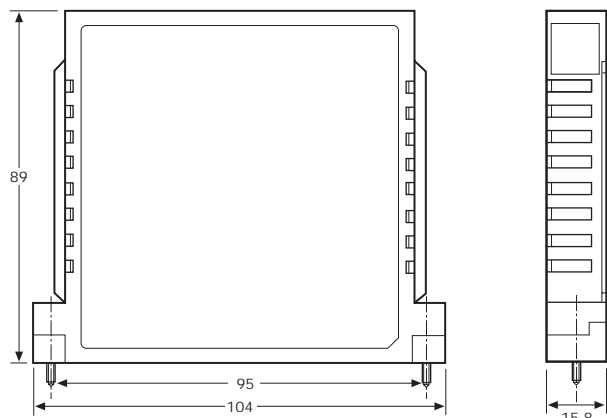

# MTL4840 SERIES BACKPLANES SPECIFICATIONS GENERAL PURPOSE VERSIONS

## BPHM64 BACKPLANE

### Capacity

- 1 x MTL4841 communications module
- 4 x MTL4842 HART® interface modules
- NB: An MTL4841 module is needed for only one in every sixteen MTL4842 modules

### Maximum power requirements

- 1.35W when equipped with:-
- 1 x MTL4841 communications module
- 4 x MTL4842 HART® interface modules

### HART interface connectors

- 4 x DIN41651 20-way ribbon cables
- (16 HART® signal connections + 4 common returns on each cable. Connections to HART® signals via screw terminal interface or custom backplane. Contact MTL for details.)

### Weight (excl. modules and accessories)

296g approx.

## HMU16/32

### Capacity

- 1 x MTL4841 communications module
- 2 x MTL4842 interface modules

### Power requirements, Vs

- 21 to 35V dc through plug in connectors

### Maximum power requirements

- 1.2W when fully populated

### Interface bus connectors

- 10-way ribbon socket

### RS485 port

- 2.5mm<sup>2</sup> screw terminals

### Mounting

- Supplied fitted with DIN-rail (T-or G-section)

### Weight (excl. modules and accessories)

330g

## COMMON SPECIFICATION BPHM64 & HMU16

### Power requirements, Vs

- 21 to 35V dc through plug-in connectors

### Mounting

- Supplied fitted with DIN-rail (T- or G- section) carrier

### Interface bus connector

- 10-way ribbon socket

### RS485 port

- 2.5mm<sup>2</sup> screw terminals

## HCU16 HART® CONNECTION UNIT

### Accuracy (HCU16-P250 only)

250Ω ±0.05%

### Connectors

- 2.5mm<sup>2</sup> screw clamp terminals
- 3 terminals per channel
- 20-way flat cable (to BPHM64)

### Weight

383g

## HCU16AO HART® CONNECTION UNIT WITH FILTERS

### Series impedance

- dc < 2Ω
- HART® signal > 240Ω

### Connectors

- 2.5mm<sup>2</sup> removable screw clamp terminals
- 2 terminals per channel in groups of 4 channels
- 20-way flat cable (to BPHM64)

### Weight

768g

## COMMON SPECIFICATION HCU16 & HCU16AO

### Capacity

- 16 channels

### Isolation

- Channel to channel 50V dc

### Mounting

- Supplied fitted with DIN-rail (T- or G- section) carrier

## DIMENSIONS (mm)

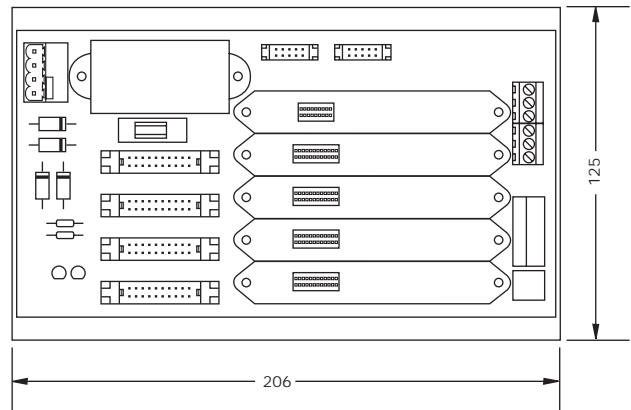

BPHM64

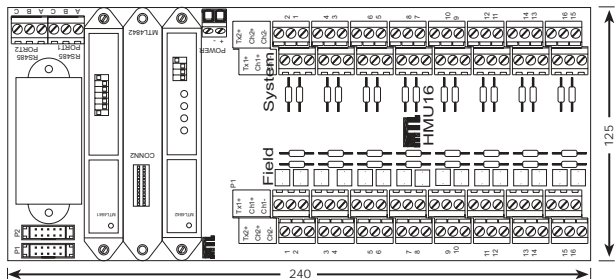

HMU16AI

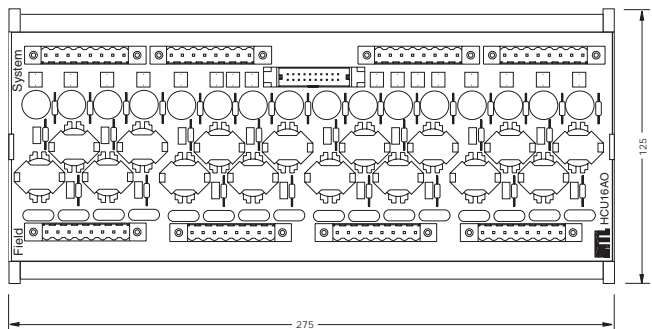

HCU16AO

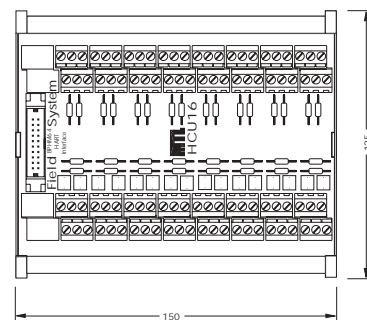

HCU16



# MTL4840 SERIES BACKPLANES SPECIFICATIONS INTRINSIC SAFETY VERSIONS

## BPMH16/BPMH16U/BPSH16/BPSH16-32 BACKPLANES

### Capacity

16 x MTL4041A, MTL4041B, MTL4041P, MTL4046,  
MTL4046C, MTL4046P isolators (except BPSH16-32)  
16 x MTL4044 (BPSH16-32 only)  
1 x MTL4841 communications module  
1 x MTL4842 HART® interface module (2 x MTL4842 on  
BPSH16-32)

NB: An MTL4841 module is needed for only one in every  
sixteen MTL4842 modules

### Power requirements, Vs

21 to 35V dc through plug-in connectors

### Maximum power requirements

1.35A (1.55A BPSH16-32)

### Safe-area connectors

BPMH16: Elco 8016 38-pin male connector  
BPMH16U: To customer's requirements  
BPSH16: 2.5mm<sup>2</sup> screw terminals (2 terminals/module)  
BPSH16-32: 2.5mm<sup>2</sup> screw terminals (4 terminals/module)

### RS485 port

2.5mm<sup>2</sup> screw terminals

### Accuracy

BPSH16-32R: 250Ω ±0.05% conditioning resistor

### Weight (excl. modules and accessories)

350g approx.

## ACCESSORIES

(for BPMH16/BPMH16U/BPSH16/BPSH16-32 backplanes)

- ERK18** Earth rail kit
- TSK18** Tagging strip kit
- VMPH16** Vertical mounting plate
- SMSO1** Surface mounting kit for backplanes, pack of 40
- DMKO1** DIN-rail mounting kit (T- or G-section) for VMPH16 mounting plate, pack of 40
- ELC38** Elco 8016, 38-way cable plug kit
- FUSO2** Fuse kit, protects MTL4841/4842, pack of 10
- FUS16** Fuse kit, protects module positions 1 to 16, pack of 10

(for MTL4000)

- CCH01** Hazardous-area crimp connector
- SCC01** Hazardous-area screw-clamp connector
- CRC01** Large crimps, pack of 100
- CRC02** Small crimps, pack of 100
- CRT01** Crimp tool for CRC01
- CRT02** Crimp tool for CRC02
- CRR01** Crimp removal tool for CRC01 and CRC02

## CUSTOMISED CONNECTION UNITS

MTL offers a range of general purpose and IS interfaces providing direct connection with control system I/O cables as well as HART® connectivity. For IS applications, MTL's universal backplanes, with a customised adapter card, give the user a compatible system connector complete with HART® interface. BPMH16U (see overleaf), BPM16U and BPM32 (see 'System Integration' section) backplanes may be used for IS signals. For general purpose signals, a range of custom HART® interface termination units are available for most DCS and PLC I/O cards. These replace the existing DCS termination units, saving space and allowing easy upgrading. Please contact MTL for details.

## DIMENSIONS (mm)

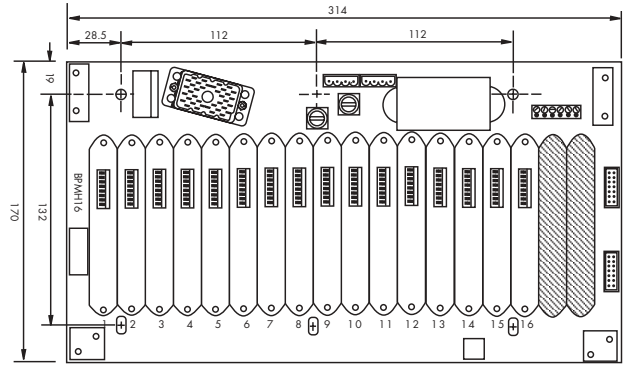

BPMH16 backplane

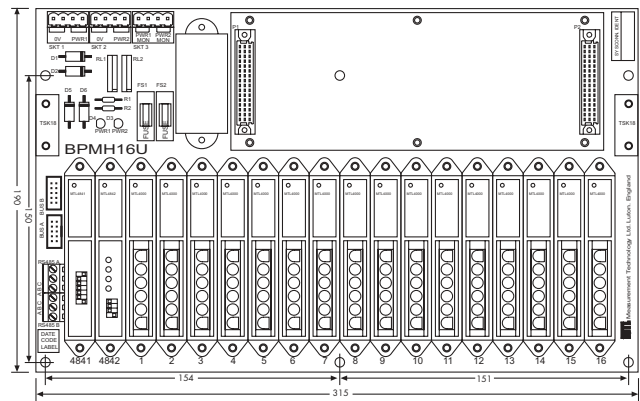

BPMH16U backplane

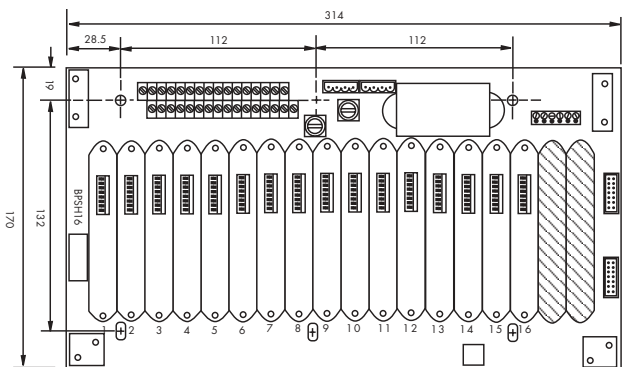

BPSH16 backplane

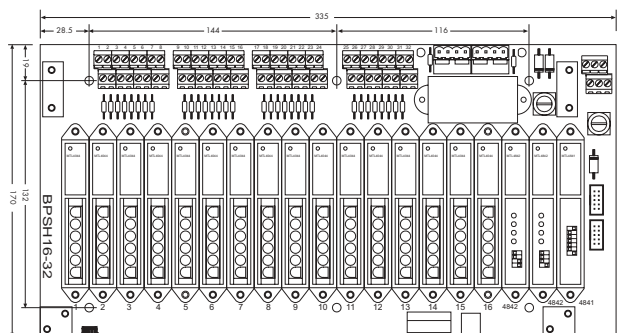

BPSH16-32 backplane



# INSTRUMENT MANAGEMENT SOFTWARE

Powerful instrument management software is being widely adopted to provide detailed information for a broad range of HART® field devices. The MTL HART® connection provides on-line access from a PC to the HART® field device for configuration and calibration as well as for diagnostics for monitoring device performance. HART® devices may be selected for regular status monitoring and an alert issued if the status changes.

Instrument management software is also used with the HART® connection to automate the record keeping required for quality assurance and regulatory compliance. This provides the following benefits:

- ◆ Reduced commissioning time and costs.
- ◆ Status monitoring to reduce process downtime.
- ◆ Field device diagnostics to reduce loop maintenance costs.

In addition, MTL's HART® connection system supports dedicated software packages for valve positioners to optimise valve maintenance schedules. Among the software currently supported by MTL's HART® connection systems are:

Cornerstone	Applied System Technologies
AMS	Emerson Process Management
Valvue	Masoneilan
SoftTools	Flowserve
HART OPC Server	HART Communication Foundation
PDM	Siemens
PRM	Yokogawa
Field Care	Metso Automation/Endress & Hauser
Smart Vision*	ABB
ValveLink	Emerson Process Management

\*Interface under development

**MTL is continually adding to the list of software supported.**



**Contact your local MTL office for details.**

The HART® OPC Server is a software application that provides a method for accessing the real time process and diagnostic information available in HART® field instrumentation. HART® capable instruments can be directly connected to the PC serial port through commonly available RS-232 interfaces. Systems of HART® devices can be connected through MTL multiplexers and I/O systems. The server is an OPC compliant server that can provide many common data items using standard OPC client applications (i.e. Wonderware, Fix, etc.).



**SoftTools** PC-based software allows the operator to run diagnostics and signatures, calibrate, display parameters, log data, set alarms and perform many other functions in a familiar Windows environment with on-line help files. Data transfer with the SoftTools software is substantially faster than other current HART® - compatible systems, resulting in a dramatic speed increase in configuration and diagnostic signature acquisition.



**Valvue** is the Windows-based diagnostic software for communication with Masoneilan's Smart Valve Interface. This easy to learn software with context sensitive help screens provides unparalleled connection to the field and enhanced features and functions.



### **FieldCare - The Open Approach to asset management**

FieldCare is an open solution for configuration and condition monitoring, achieved through support of the multi vendor FDT/DTM standard. It allows for Multi Communication Support through FDT and will support all communication protocols and nested communication. Hence it allows the user to select 'Best in Class' devices, with full software support, in a common tool. With support for FDT across many system vendors the package allows for simplified system integration.

The package provides:

- ◆ Operation of third-party devices using either vendor or generic device type managers (DTMs)
- ◆ Support for HART, PROFIBUS and Foundation Fieldbus devices
- ◆ Network configuration, device navigation and management of DTMs
- ◆ Tracking of user changes
- ◆ User management

The maintenance package includes in addition:

- ◆ Asset management based on easy Condition monitoring
- ◆ Alarm notification
- ◆ Open database connectivity to other software

So FieldCare aims to provide the best possible support during the commissioning, operation and maintenance of your plant.

HART® is a registered trademark of HART Communication Foundation  
Cornerstone® is a registered trademark of Applied System Technologies Inc  
Windows® is a registered trademark of Microsoft Corporation  
Masoneilan® is a registered trademark of Dresser





**Cornerstone**  
The Open Platform for Instrument Management

## Instrument management software from MTL

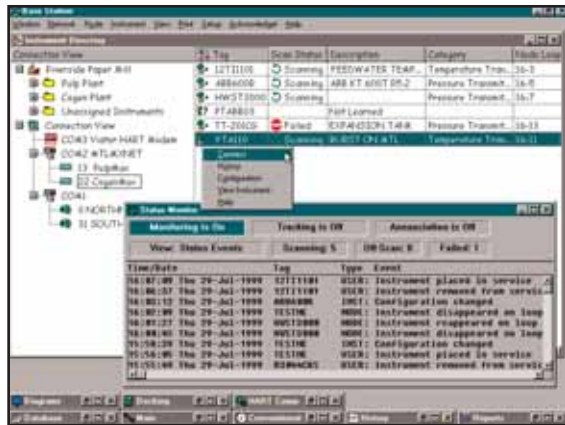

The **Cornerstone™ family of software products** provides a Windows based interface to comprehensive HART instrument asset management software over MTL4840 HART multiplexer networks. It allows users to calibrate, configure and maintain an entire network of devices from a single workstation independently but concurrently with the Control system. The recent launch of Version 5 offers numerous improvements to an already powerful Instrument Management platform including:

- Operational and performance improvements
- Expanded transaction security and audit tracking
- Enhanced display and presentation features
- Simpler input and selection actions

Each MTL Cornerstone Package contains the following four components as standard:- Base Station, ISM, All Mod libs and MTL ComLib.

**Base Station** maintains a comprehensive instrument data base, with individual histories of the configuration, test, calibration and maintenance activities performed on each instrument. The itemized record keeping supports compliance with audit requirements.

**The Instrument Status Monitor (ISM)** can continuously monitor thousands of HART instruments that are attached through the MTL4840 or MTL8000 process I/O. The MTL HART Maintenance system automates plant-wide scanning and status monitoring of all attached HART instruments. Any configuration changes, including those made in the field, are detected and recorded. With this on-line maintenance station, you can:

- Automatically build your instrument database - no individual data entry required, a major benefit when retrofitting HART Maintenance systems
- Access and modify instrument operational parameters

- Detect, annunciate, and remedy field instrument problems
- Schedule and manage calibration

**The ModLibs Package, "ModLibs"**, are the libraries that enable Base Station to read, process, display and modify the individualized parameters and functions in a specific model of smart instrument.

**The Cornerstone MTL Communications Library (ComLib)** provides the software connection between Cornerstone Base Station software and networks of MTL Hardware.

Optional components include:-

**Field Station** which acts as a remote satellite of Base Station for direct configuration and calibration activities.

**Calibrator Interface Libraries** provide interfaces to various models of intelligent calibration equipment. On-line CalLibs enable Base Station to automate the performance of multi-point test and calibration.

Base Station software may either be used on a stand-alone computer, or as the first Cornerstone station in a networked configuration. Three optional Multi-user Kits add Cornerstone stations (called SubStations) to the Home Base Station. Kits are purchased separately and are available in three sizes, providing a total of 3 users, 6 users, or 10 users.

MTL cornerstone packages include:

- 191600 MTL On-line Package (128 devices)
- 191610 MTL On-line Package (512 devices)
- 191620 MTL On-line Package (2000 devices)
- 191630 MTL On-line Package (8000 devices)

Cornerstone® is a registered trademark of Applied System Technologies Inc.

HART® is a registered trademark of HART Communication Foundation.

Windows® is a registered trademark of Microsoft Corporation.



EUROPE (EMEA) Tel: +44 (0)1582 723633  
AMERICAS Tel: +1 603 926 0090  
ASIA PACIFIC Tel: +65 487 7887  
E-mail: enquiry@mtl-inst.com Web site: www.mtl-inst.com

Fax: +44 (0)1582 422283  
Fax: +1 603 926 1899  
Fax: +65 487 7997



## Instrument management software from MTL

# AMS



**With annual spending on maintaining existing plant** being five times the expenditure on new plant, and with one third of all maintenance costs wasted due to unnecessary or improperly performed maintenance procedures, there are huge opportunities for improving plant profitability through the use of effective maintenance management tools. In the process industry effective management of instrumentation assets is a key requirement for maximising profits. AMS Device Manager is a key element in achieving this.

**AMS Device Manager** can be used with the MTL4840 HART<sup>®</sup> connection system, and with any control system, to give precise live information about every HART transmitter and valve positioner in a plant. Imagine—a software application which can identify problems with instruments; an application which predicts upcoming problems; an application which offers you access to device status information that can reduce troubleshooting time by three hours or more per device.

**Avoid Unplanned Shutdowns.** Online access to device diagnostics allows you to continually monitor devices and to know immediately if there is a problem. Intercept problems before they cause major plant upsets.

*"Without AMS, maintenance would have shut down the process for four or five hours to replace a valve that was in good working condition."*

**- Goldschmidt Chemical Corporation**

**The Power of Diagnostics.** AMS ValveLink delivers exclusive, in-service Performance Diagnostics for the best predictive valve diagnostics available.

*"There is no question that diagnostic capabilities, like the Alert Monitor, saved us considerable time and money compared to traditional methods. Emerson has some of the best tools in the industry to improve diagnostics, increase system availability, and lower production costs."*

**- Cargill**

**Streamline Calibrations.** AMS Device Manager allows you to easily move information between your database and your documenting calibrator. Calibrator results are archived along with all maintenance information for each device, helping you comply with regulatory agencies.

*"Through AMS the frequency of some calibration routines has been halved. AMS paid for itself in just two days of production following early startup."*

**- GlaxoSmithKline**

**Attain Superior Performance.** You have the ability to check a device status, configure, re-range, and perform diagnostics right from a PC without going into the field.

*"Emerson's AMS works with predictive diagnostics in the field devices to give us increased performance from our process....of approximately a 1% product improvement or an additional 600 barrels/day."*

**- Shell Refining**

**Deliver an Audit-Ready Plant.** Documentation time is dramatically reduced. All information for each device is stored by the AMS Device Manager and documentation is updated automatically.

*"Auditors are impressed when we go to the computer and print out a detailed report showing scheduled calibration dates, when last calibrated, and 'as found/as left' information. Everything is very well organized, and the accuracy of these reports has never been questioned."*

**- American Soda**

AMS Suite: Intelligent Device Manager is just one of the integrated family of applications in the AMS Suite for predictive maintenance, performance monitoring and economic optimization.

HART<sup>®</sup> is a registered trademark of The HART Communication Foundation.



EUROPE (EMEA)  
AMERICAS  
ASIA PACIFIC  
E-mail: [enquiry@mtl-inst.com](mailto:enquiry@mtl-inst.com)

Tel: +44 (0)1582 723633  
Tel: +1 603 926 0090  
Tel: +65 487 7887

Fax: +44 (0)1582 422283  
Fax: +1 603 926 1899  
Fax: +65 487 7997

Web site: [www.mtl-inst.com](http://www.mtl-inst.com)

May 2004

## MTL4840 SERIES ORDERING INFORMATION



### MTL4840 Series modules

MTL4841	HART communications module pre-configured for Cornerstone™ protocol
MTL4841-AMS	HART communications module pre-configured for AMS Intelligent Device Manager
MTL4841-PRM	HART communications module pre-configured for PRM
MTL4842	HART interface module communicates with up to 16 loops

## THE COMPLETE SYSTEM

The following components form a complete system:

**MTL4840 HART® connection system** – provides simple connection to field instruments, using general purpose and IS termination boards.

**Personal computer** – running instrument management software and linked to MTL4841 HART communications modules by:

**Converter** – connecting the computer's RS232 port to the MTL4840 Series' backplane RS485 connector.

**Instrument management software**

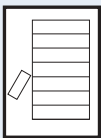

### General purpose connection units

BPHM64	64 ch HART backplane
HCU16	HART connection unit
HCU16-P250	HART connection unit
HCU16-S200	HART connection unit
HCU16-S150	HART connection unit
HCU16AO	16 ch HART connection unit
HMU16	16 ch HART communication unit

HART interface connector  
 No parallel resistor, 0Ω link fitted in series  
 250Ω parallel resistor, 0Ω link fitted in series  
 No parallel resistor, 200Ω resistor fitted in series  
 No parallel resistor, 150Ω resistor fitted in series  
 With HART filters

### MTL4000 backplanes

BPMH16	16 ch backplane
BPSH16	16 ch backplane
BPSH16-32	32 ch HART backplane
BPMH16U	16 ch HART backplane

Safe-area multiway connector  
 Safe-area screw-clamp connector

Requires backplane adapter card (call MTL for options)

### Backplane accessories

ERK18	Earth rail kit
TSK18	Tagging strip kit
ELC38	38-way Elco connector
FUS02	Fuse kit, pack of 10
FUS16	Fuse kit, pack of 10
VMPH16	Backplane mounting plate

For BPMH16 and BPSH16 backplanes  
 For BPMH16 and BPSH16 backplanes  
 For BPMH16 safe-area connection  
 Protects MTL4841/4842  
 Protects backplane module positions 1 to 16  
 For DIN-rail and non-metallic surface mounting (BPMH16 and BPSH16 only)  
 Pack of 40 - 4 required for each backplane  
 Pack of 40 - 4 required for each backplane  
 -xx specifies the cable length - max 4m  
 -xx specifies the cable length - max 4.5m

### Isolating interface modules and accessories

MTL4041A	Current repeater
MTL4041B	Repeater power supply
MTL4041P	High power repeater power supply
MTL4044	Repeater power supply
MTL4046	Isolating driver
MTL4046C	Isolating driver
MTL4046P	High power isolating driver
CCH01	Crimp connector header
CRC01	Large crimps
CRC02	Small crimps
SCC01	Screw-clamp connector
MPL01	Module position label, blank

4/20mA, passive input, for smart transmitters  
 4/20mA, for 2- or 3-wire transmitters  
 4/20mA, for 2- or 3-wire transmitters  
 2ch, 4/20mA, smart, for 2-wire transmitters  
 For HART valve positioners  
 For HART valve positioners  
 For HART valve positioners

Pack of 100

Pack of 100

Pack of 50

### Literature

INM4840	MTL4840 instruction manual
---------	----------------------------

**APPROVALS - for the latest certification information visit [www.mtl-inst.com/certs\\_1.nsf](http://www.mtl-inst.com/certs_1.nsf)**

<b>Country</b>	US
<b>Authority</b>	FM
<b>Standard</b>	Class 3600, 3611, 3810 Class 1, Div 2, Gps ABCD
<b>Product No.</b>	<b>Certificate No.</b>
MTL4841	3009149
MTL4842	3009149
HCU16	3009149
BPMH64	3009149



EUROPE (EMEA) Tel: +44 (0)1582 723633 Fax: +44 (0)1582 422283  
 AMERICAS Tel: +1 603 926 0090 Fax: +1 603 926 1899  
 ASIA PACIFIC Tel: +65 487 7887 Fax: +65 487 7997  
 E-mail: [enquiry@mtl-inst.com](mailto:enquiry@mtl-inst.com) Web site: [www.mtl-inst.com](http://www.mtl-inst.com)